

Installation Manual

Block Programmable Receiver 800/1600 Users SEL2641R433-K8/K8P/K16P

*We appreciate your choice of this product.
This product is addressed to manage the access in
automatic door control systems
This appliance has been carefully manufactured and checked.
The manufacturer has designed this system to assure the best reliability and
satisfaction in the time
We recommend to read carefully this manual before to proceed to the installation*

IS-CNBTSUK Rev. 0 del 11/05/2009

GUARANTEE

The warranty period of Transmitter Solutions receivers is 24 months, beginning from the manufacturing date of the transmitter. During this period, if the product doesn't operate correctly, due to a defective component, the product will be repaired or replaced at the sole discretion of Transmitter Solutions. The warranty does not extend to the receiver case which can be damaged by conditions outside the control of Transmitter Solutions.



Transmitter Solutions
2505 Chandler Avenue, Suite, 1
Las Vegas, NV 89120 -
(866) 975-0101 - (866) 975-0404 Fax
sales@transmittersolutions.com



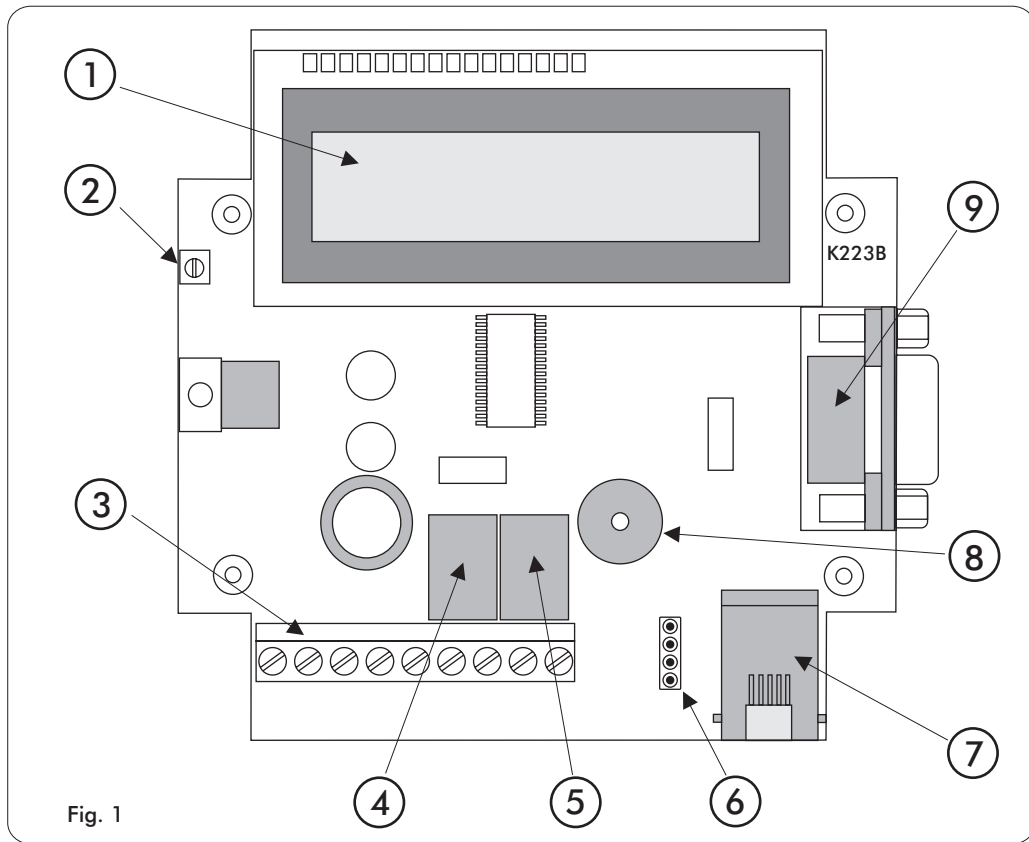

Fig. 1

Legend

- 1 : Backlighted LCD display
- 2 : LCD trimmer adjust
- 3 : Terminal boards
- 4 : Relay 1
- 5 : Relay 2
- 6 : 4 pin strip connector
- 7 : RJ11 phone connector
- 8 : Buzzer
- 9 : D-type 9 pin male connector
- 10 : Plugs
- 11 : Screws
- 12 : Aerial net
- 13 : Receiver box

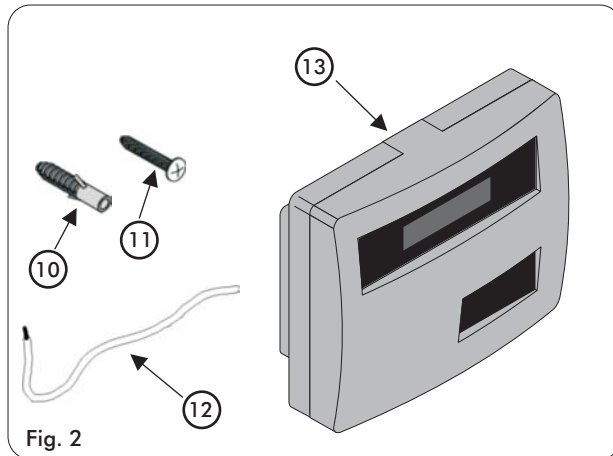

Fig. 2

Accessories

For the functionality of the receiver the following accessories are available:

- A) TX PROGRAMMING CABLE with PROBE (Fig. 15)
- B) CONNECTION RECEIVER - RECEIVE CABLE (fig. 16)
- C) SERIAL CABLE to a serial printer (Fig. 17)
- D) BACKUP MEMORY (Fig. 18).



Fig. 15



Fig. 16



Fig. 17



Fig. 18

RS232 Connection

The receiver can be connected to a terminal (VT100) to a PC or to a serial printer through a 9-ways D-type male connector. The interface is a RS232C with the following parameters:

Baud-rate: 2400 Baud
 N° bits: 8
 Parity: None
 Stop bits: 1

Signal	Pin connection
RD (Receive Data)	2
TD (Transmit Data)	3
SG (Signal Ground)	5

According to the connected device, the connecting cable has to be as follows:

1) Connection Receiver - PC Serial Port (D-type 9 pin Male connector)

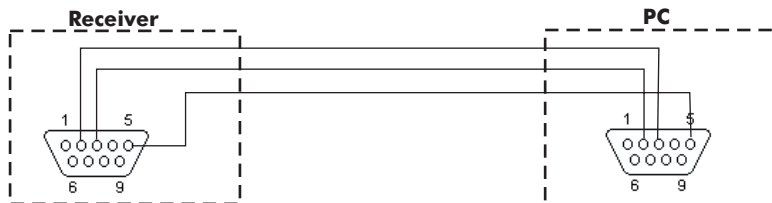

2) Connection Receiver - PC Serial Port (D-type 25 pin Male connector)

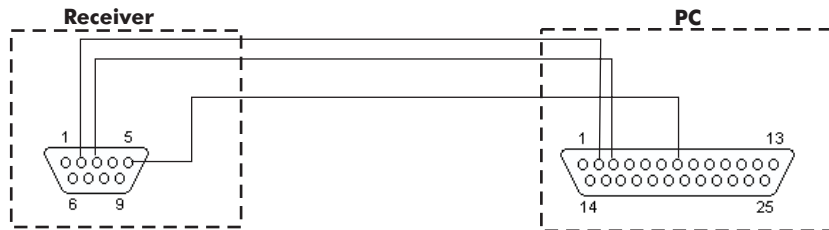

3) Connection Receiver - Printer Serial Port (D-type 25 pin Female connector)

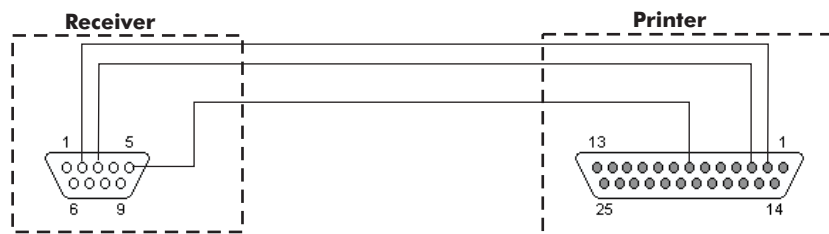

4) Connection Receiver - Printer Serial Port (D-type 9 pin Female connector)

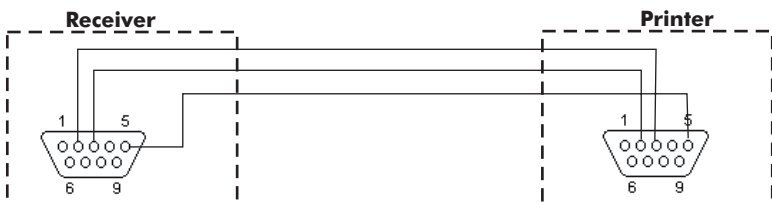

Contents

Important Recommendations	Pag. 4
General Remarks	Pag. 4
Receiver composition	Pag. 4
Versions	Pag. 4
Technical specifications	Pag. 4
Compatibility	Pag. 5
Introduction	Pag. 5
MASTER transmitter use guide	Pag. 5
USER transmitter use guide	Pag. 5
KEYPAD use guide	Pag. 5
Installation	Pag. 6
Electrical connections	
Transmitters programming	Pag. 7
MASTER transmitter memorization	
USER transmitter memorization	
Main menu structure	
Menu Delete	Pag. 9
Single user cancellation	
All users cancellation	
Complete initialization of the receiver	
Menu Modify user	Pag. 10
Enable / Disable	
Modify relay or key parameters	
Copy and data transfer menu	Pag. 11
Memory Visualization on the LCD	
Print user list	
Print events	
Transmitter S/N configuration	
Data transfer from and to a backup device	
Receiver configuration menu	Pag. 15
Change Password	
Relay configuration (Relay1 - Relay 2)	
Facility Code set-up (Facility Code 1 - Facility Code 2)	
Receiver auto-test system	Pag. 17
RS232 Connections	Pag. 18
Accessories	Pag. 19

Important recommendations

- Never interfere with the product when connected to a power source;
- Avoid direct contact with water;
- Regularly check the state of the product;
- Respect the current norms;
- Wear protected glasses to avoid injury during the drilling phase;
- Change the factory code;

General remarks

Radio

The materials and the technology used have made it possible to create a system functioning on the 433.05 - 434.790 MHz frequency band, used by LPD equipments and therefore subject to European radio and electromagnetic compatibility regulations (CE).

Rolling Code

In order to guarantee your safety and the total inviolability of the communication between transmitter and receiver, the code sent out by the transmitter changes every time the equipment is used and is recognised by the receiver only, thanks to an unfalsifiable code-setting calculation. The system thus conceived avoids all risk of being recording or of the code being copied (268 million combinations).

Composition of the receiver

See fig. 2

Item	Description	Q.ty
1	Receiver	1
2	Antenna wire	1
3	Assembly screws	4
4	Plugs	4

Versions

SEL2641R433-K8	RX 800 Users
SEL2641R433-K8P	RX 800 Users PCCOM (*)
SEL2641R433-K16P	RX 1600 Users PCCOM (*)

(*) PCCOM : Internal firmware with predisposition for the connection to a PC with Software PCCOM

Technical specifications

Receiver

Carrier frequency	433.92 MHz
Local oscillator freq.	6.6128 MHz
Power supply	12/24 Vac/dc
Modulation	AM/ASK
Number of memorizable users	807
Number of relays	2
Type of output contact	1 NO, 1 NO/NC
Commutable power	24 VA
Maximum relay voltage	60 V
Absorption	95 mA (relay excited)
Housing protection	IP 40
Operating temperature	from 14 °F to 131 °F
Overall dimensions	7.08 x 5.51 x 2.67 in
Weight	11.35 oz.

(*) According to the version

• Transmitter Types E2-E4-E2M

Operating Frequency	433.92 MHz
Power supply	12 Vdc
Modulation	AM/ASK
Number of functions	2 or 4
Coding type	Rolling Code
Number of combinations	2 ⁶⁴
E.r.p.	50 - 100 μW
Absorption	18 mA
Range in open space with receiver with antenna	100-200 meters
Housing protection	IP 44
Operating temperature	from 14 °F to 131 °F
Dimensions	3.22x1.88x0.629 in
Weight	1.128 oz
Battery type	Alkaline - 23A

Compatibility

Look at the following table for the compatibility between the receiver and the different series of Transmitters

Receiver	Transmitters
SEL2641R433-KX	S2TR2641E2 - E4 - E2M (Series 024A) SETR2641AM2 (Series mini AM) SEDK2641A4 (Digikey)

Number of the stored USER transmitters

At the point N° 6 of the main menu, the program shows the number of the USER transmitters present in the memory.

This number refers only to the USER transmitters and not to the MASTER transmitters, which can be up to 7. This number is updated after any variation (new memorization / cancellation, memory initialization).

Receiver auto-test system

The receiver contains an auto-test system which makes it possible to identify incorrect usages or readings.

Example of the message on the display:

SYSTEM
ERROR

CODE	DESCRIPTION	ACTION
1	Impossible to write on the memory	Memory empty. Return the receiver to the factory
2	Reading or writing error on the display	Copy the contents of the receiver to the backup and memory and return the receiver to the factory.
4	Faulty transfer of the data to a transmitter via connecting cable	Repeat the programming of the transmitter. If the message is persistent, check the memory position on the receiver, memorize again, and then start transfer again.
8	Used for checking during production	
16	Used for checking during production	
32	Writing on the last memory position Es. 800 or 812.	Memory full Last memory position: use a previous position or replace a position already used.
64	Radio signal received too weak	Check the charge on the batteries of the transmitter or bring the transmitter near the receiver
128	Transmitter counter not synchronized	Transmit a second time If the message persists, eliminate the memory position of the transmitter and then memorize again. If, after the transfer of a transmitter, the number of impulses allowed (16) has been exceeded, the counter will no longer be synchronized and the transmitter cannot be memorized in the receiver.

Relay configuration (Relay1 and Relay 2)

The operating mode of the two relays can be set in separate way.
Each relay can be configured as follows:

- **PULSE** - *Pulse operating mode*: the relay excites at the reception of a good transmitter signal and remains excited until the transmitter key is released.
- **STEP** - *Bistable operating mode* : the relays excites at the first pulse and releases at the next one
- **TIMED 6 SECONDS** - *Timed operating mode*: at the end of the received signal the relay remains excited for further 6 seconds.
- **SHORT RANGE** - *"Pedestrian operating mode"* :in this case the receiver sensitivity is reduced of 40 dB causing a big reduction of the radiocontrol range (Final range of about max 10 mt.)

Structure of the sub-menu

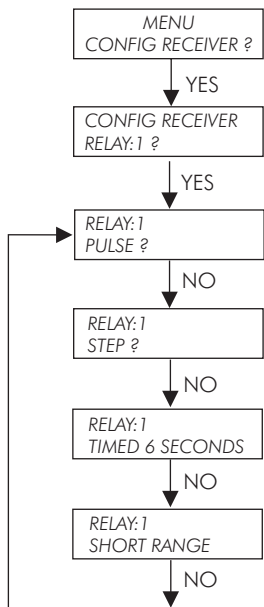

Select the RELAY 1 or RELAY 2 configuration using the LEFT Key of the MASTER transmitter and confirm with the RIGHT key : the display will give the message: EXECUTED OK and the program will return to the main menu.

Facility Code set-up

The "Facility Code " (FC) is a number, in the range : "000" to "256", sent by the transmitter with its own Serial Number (S/N).

The receiver is programmed to accept only transmitters which have 2 types of Facility Codes.
Any transmitter with facility code different from the 2 programmed won't be accepted.
Through the following procedure it is possible to set the couple of Facility Codes.

Select the option : FACILITY CODE : 1? from the receiver configuration menu using the LEFT key of the MASTER transmitter.
Confirm the choice and you will be asked for the new Facility Code.

The message prompts with the current number memorized for the Facility Code 1

F	A	C	I	L	I	T	Y	C	O	D	E	:	1	
C	H	E	C	K	F	O	R					0	0	1

You are asked to change or confirm the memory settings.
In the case above, the receiver accepts only transmitters with Facility code = 001.
Config the Facility Code making use of the MASTER transmitter, or the KEYPAD or by using the key B of a transmitter with the desired Facility code.

At the end appears the message: EXECUTED OK and the program return to the main menu.

The procedure to set the Facility Code 2 is similar to the other.
On the display will appear "Facility Code 2".

F	A	C	I	L	I	T	Y	C	O	D	E	:	2	
C	H	E	C	K	F	O	R					0	0	1

NOTE : the Facility code Null ("000") has a special meaning.
In this case the Facility Code check is completely disabled.

Introduction

This receiver allows to manage 800 pre-coded transmitters (2 or 4 keys) for a wireless access control system.
There are 2 output relays with NO and NC/NO contacts.
The managing of the users is fully wireless: the receiver can be programmed by using a special transmitter called "MASTER transmitter".
This is memorized during the first installation.
The internal EEPROM allows to memorize up to 7 MASTER transmitters.
All the operations are displayed through a 16x2 backlighted LCD display.
The menu is friendly and very easy.

Master transmitter use guide

Each MASTER transmitter allows to set the receiver using just 2 keys.
The transmitter keys can have different meanings depending upon the phase, as shown in the following examples:

Answer to a question

Activation of the **LEFT** key
Answer **NO** to a question



YES
Activation of the **RIGHT** key
Answer **YES** to a question

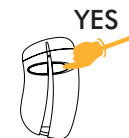

Number setting

Activation of the **LEFT** key
Cyclical scroll upwards a digit



Activation of the **RIGHT** key
Gives confirmation to the present digit and shifts the cursor to the next digit of the number.



Menu managing

Activation of the **LEFT** key
Cyclical scroll of the available options of a menu



Activation of the **RIGHT** key
Confirm the choice and entry into the lower menu



Simultaneous activation of the both keys
LEFT and **RIGHT** : Back to the previous menu

User transmitter use guide

The standard transmitters (called USER Transmitters) are memorised making use of the MASTER transmitter (in single mode or by blocks).
The USER transmitter keys activate the relays according to the memorised configuration.
During the normal use, the simultaneous activation of both the keys of the transmitter is disabled.
This facility is only used during the programming procedure (see pag. 8).

Keypad use guide

The receiver can be programmed using the transmitter DIGIKEY, called KEYPAD.
See. Fig. 3 the correspondance between the transmitter keys and the Keypad keys.

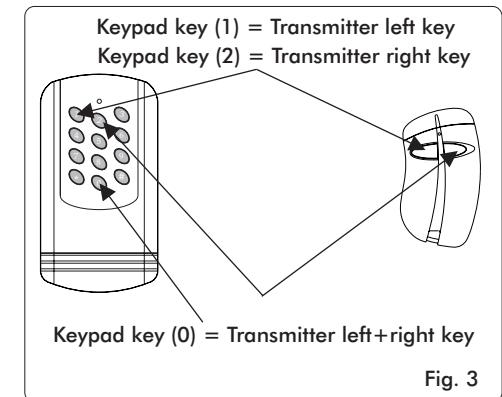
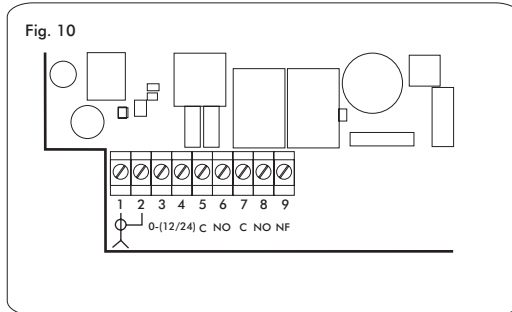
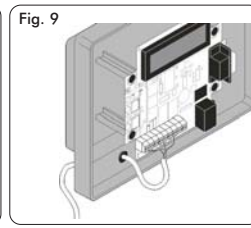
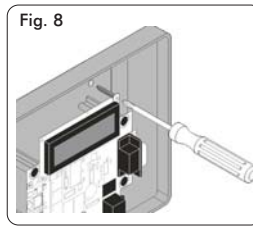
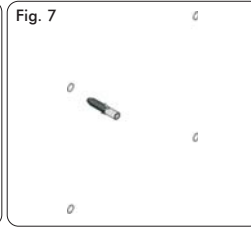
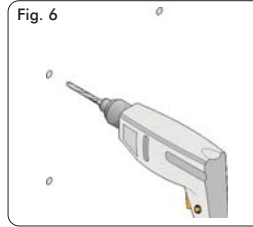
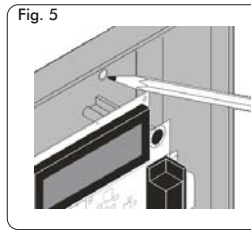
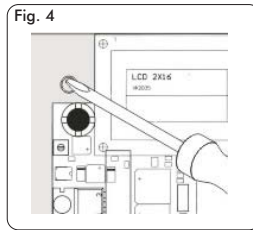

Fig. 3

Installation

- Position the receiver on a plane, open it and remove the pre-forated parts (fig. 4) situated at the back of the receiver with the aid of a screwdriver.
- Make a hole in the pre-forated parts (5) (fig. 6).
- Put the plugs in the holes (fig. 7) or adapt the holes to the nature of the support.
- Fix the receiver using the screws supplied (fig. 8).
- Make holes in the guiding slits (only in those used), and proceed to the electric connection (fig. 10), and thread the wires through the guiding slits (fig. 9).



Advice

When assembling the equipment outdoors, we advise you to protect the receiver in a container with an IP54 level of protection.

Electrical connections



Advice

A telephone wire (0.6 mm²) is sufficient for the input of the receiver and the relay cabling.

Receiver power supply:

- connecting clip 3: 0V
- connecting clip 4: 12/24 Vac/dc

Connect the output contacts:

- connecting clip 5: common relay 1
- connecting clip 6: NO contact relay 1 (contact normally open)
- connecting clip 7: common relay2
- connecting clip 8: NO contact relay 2 (contact normally open)
- connecting clip 9: NC contact relay 2 (contact normally closed)

Connect the antenna

- connecting clip 1: antenna conductor or antenna wire supplied with the receiver



Advice

The installation and positioning of the antenna are fundamental for good reception. Carry out tests before fixing the antenna definitively. Place the antenna as high as possible and far from all types of metal structures which could shield the receiving part of the antenna.

Receiver configuration menu

In this sub-menu you find the options for :

- Password modification;
- Relay1 configuration setup;
- Relay2 configuration setup;
- Facility Code 1 setting;
- Facility Code 2 setting.

Menu structure

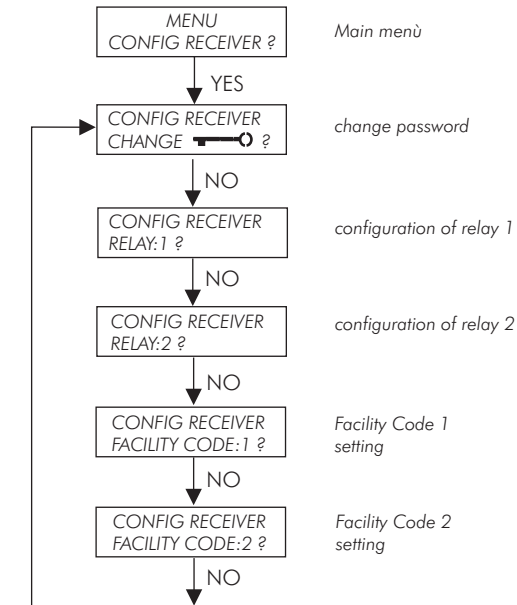

Change password

Select this option to change the current password and the following message will appear on the display:

C	O	N	F	I	G	R	E	C	E	I	V	E	R		
C	H	A	N	G	E										

Confirm with the RIGHT key of the MASTER transmitter. The password settings can be as follows:

1) The current password is Null ("00000"): password disabled.

In this case you are asked for the new password (see below). Entry twice the same number.

N	E	W													
I	N	S	E	R	T									0	0

N	E	W													
C	O	N	F	I	R	M								0	0

2) The current password is different from the Null ("00000"): Password enabled.

In this case you are asked first to compose the current password and then to compose twice the new one (see below).

C	U	R	R	E	N	T									
I	N	S	E	R	T									0	0

N	E	W													
I	N	S	E	R	T									0	0

N	E	W													
C	O	N	F	I	R	M								0	0

NOTE:

1) Null Password ("00000") means Password disabled. When the password is set to a value different from Null ("00000") on the display appears the message:

ENABLED EXECUTED OK

When the password is set to a value Null ("00000") on the display appears the message:

DISABLED EXECUTED OK

2) The receiver is sold with the preset-in-factory default Password ("11111").

Data transfer from and to a backup device

Through these 2 sub-menu it is possible to copy the entire memory data onto a backup device (a backup memory or a spare receiver) or restore the data from a backup device.

For a backup device it is possible to use the backup memory (see. fig. 18 on pag. 19). This has to be inserted on the 4-ways strip connector (ref. 6 on pag. 2) respecting the insertion sense.

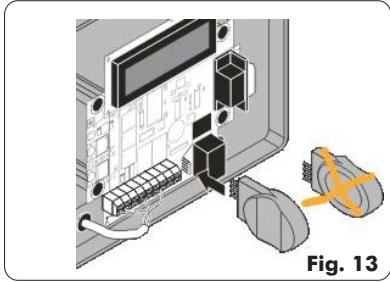

Fig. 13

As backup device it is also possible to use a spare receiver and connect the 2 appliances with a net telephone cable with RJ11 connectors (See Fig. 16 on pag. 19). See the connection below on fig.14

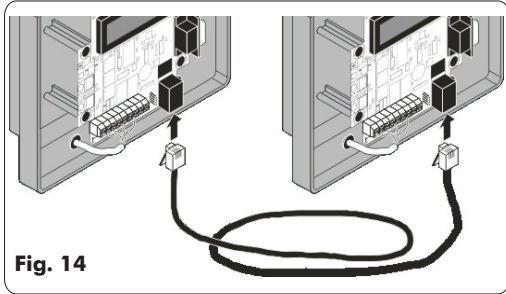

Fig. 14

Data transfer to a backup memory

Select the option:

C	O	P	Y	M	E	M	O	R	Y	O	N			
A	B	A	C	K	U	P	?							

The receiver perform a first test (on the strip connector and on the telephone connector) to verify the backup device presence.

If the test fails the following message appears on the LCD

C	O	P	Y	M	E	M	O	R	Y	O	N			
N	O	T	C	O	N	N	E	C	T	E	D	!		

Insert the memory or connect the telephone cable and confirm with the RIGHT key of the TX MASTER.

A warning message will appear:

M	E	M	O	R	Y	B	U	S	Y					
D	E	L	E	T	E	?								

The message warns that the destination memory will be fully overwritten.

With a further confirmation the transfer begins.

During the transfer on the LCD appears the message:

T	R	A	N	S	F	E	R							
I	N	P	R	O	G	R	E	S	.	.				

If the transfer is completed successfully, appears the message: EXECUTED OK and the buzzer emits 2 beeps.

Data transfer from a backup memory

Select the option:

C	O	P	Y	M	E	M	O	R	Y	F	R	O	M	
A	B	A	C	K	U	P	?							

The procedure is quite similar to the previous.

From this time on the sequence of messages is similar to the other.

In this case the internal memory data are fully overwritten by the external data (from the backup memory of from the spare receiver memory).

WARNING : Use this option carefully : if the external device data are corrupted or non updated, your data base could be unrecoverable lost.

Transmitter programming

The configuration of the receiver is possible only after the memorization of one or more MASTER transmitters. If the memory is empty, follow the following procedure:

Connect the power-supply and switch on the receiver.

On the display will appear the initial message.

The initial message can be different depending upon the password configuration (see procedure on pag. 15 for the password setting).

The receiver is sold with a default value of the password : ("11111").

T	R	A	N	S	M	I	T	T	E	R	8	0	0	



This symbol stands for "Password enabled" See pag. 15

(*) : The welcome message changes according to the version

T	R	A	N	S	M	I	T	T	E	R	8	0	0	

If the initial message has the "Welcome" instead of the key symbol, it means that the password has been reset ("00000").

MASTER transmitter memorization

Push simultaneously the keys LEFT and RIGHT of a MASTER transmitter .

On the display appears the following message:

S	N	0	0	0	0	0	E	R	L	½	K	Y	A	
S	T	O	R	E	M	A	S	T	E	R	?			

Where 00000 is the Serial Number of the Master transmitter used.

With an answer YES, the display shows " EXECUTED OK" and the transmitter is memorized.

On the first line of the display is present the information of the abilitation of the whole transmitter, the relays activated (1 or 2 or ½" both") and the corresponding transmitter keys : see pag. 10.

With an answer NO there is the return to the initial message.

Main menu structure

The menu is organized into different levels, with a main level and several lower levels. Once composed the right password you entry into the main level.

See below the structure of the main level with the different lower options.

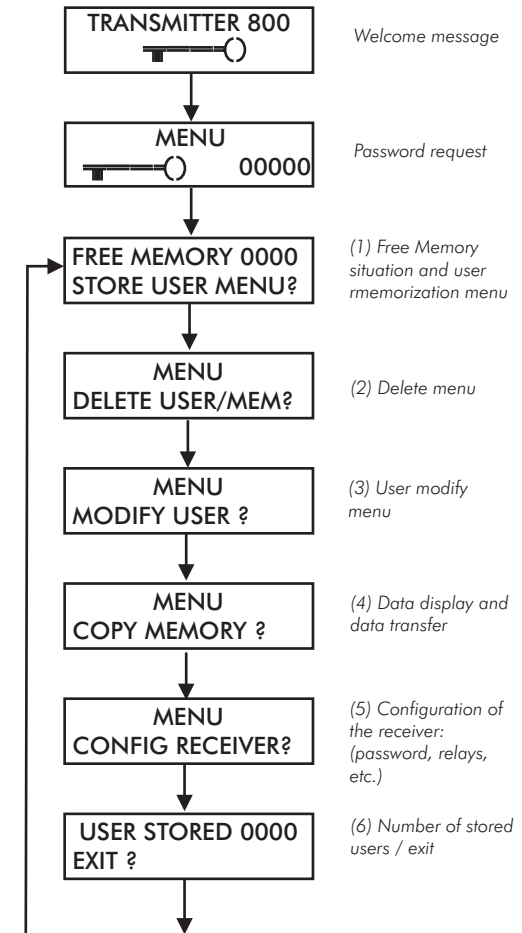

USER transmitters memorization

The procedure begins at point (1) of the main menu.

S	T	O	R	E		U	S	E	R		M	E	N	U	
U	S	E	R				S	N			0	0	0	0	1

The cursor blinks under the first left digit of the Serial Number to set.

For this operation there you can use 3 different methods:

1) With the TXMASTER

Scroll up the digit with the LEFT key (cliclically) and shift right to confirm with the RIGHT key.

Push LEFT+RIGHT keys simultaneously to cancel and to go back to the upper menu;

2) With the KEYPAD

Use the keys of the keypad to set the right number and shift right to confirm with the key (#);

3) With the TXUSER

Push the key B of the USER transmitter which has to be memorized: its Serial Number will replace the default number of the message. Then push the RIGHT key of the MASTER transmitter.

Once set (for instance) the S/N : 20160, as explained above, the program will ask for the relay [1, 2 or ½] and the keys configuration [A,B,C,D].

U	S	E	R			S	N			2	0	6	1	0
R	E	L	A	Y	:	½				K	E	Y	:	A

Modify the parameters RELAY and KEY according to your needs by using the MASTER transmitter.

The next step allows to choose a "single" or a "block" memorization.

U	S	E	R			S	N			2	0	6	1	0
S	T	O	R	E		S	I	N	G	L	E	?		

With an answer "YES" to the above question this phase ends and the message "EXECUTED OK" appears on the display.

With an answer "NO" begins the procedure for the block memorization: the display will show the S/N of the first transmitter of the block.

The next question proposed is the number of transmitters of the block.

U	S	E	R			S	N			2	0	6	1	0
H	O	W	M	A	N	Y	T	X		0	0	0	0	0

Entry the number of TX with the TXMASTER

S	T	O	R	E		0	0	0	0	T	X			
A	R	E		Y	O	U		S	U	R	E	?		

Give the confirmation with the RIGHT Key of the MASTER transmitter.

NOTE :

If the memory contains already any transmitter with S/N included in the range of the block, the entire operation is cancelled and on the display appears the following message:

S	N		X	X	X	X		R	L	X		K	Y	X
S	E	R	I	A	L		E	X	I	S	T	!		

Where XXXX is the Serial Number of the transmitter already present in the memory, RL X is the relay activated and KYX is the transmitter key associated.

Transmitter S/N configuration

Each transmitter is sold with a different Serial Number (S/N). It is anyway possible to change this number using the cable B with the special probe (see fig. on pag. 20). For this operation connect the cable to the receiver connector RJ11 (Ref. 7 on pag. 2).

Select the option "Copy memory on a transmitter" :

C	O	P	Y		M	E	M	O	R	Y					
O	N		A		T	R	A	N	S	M	I	T	T	E	R

You are asked for the Serial Number to set on the transmitter

P	R	O	G	R	A	M		T	X						
U	S	E	R					S	N		0	0	6	0	9

Dial the desired S/N and confirm with the transmitter MASTER.

The display asks for the connection:

P	R	O	G		T	X		S	N		0	0	6	0	9
C	O	N	N	E	C	T	E	D		?					

At this point open the battery door of the transmitter and connect the probe to the 7 pads present on the bottom of the transmitter card, as shown in fig. 13.

Confirm with the RIGHT key of the MASTER transmitter.

The software begins the check of the connection:

P	R	O	G		T	X		S	N		0	0	6	0	9
V	E	R	I	F	Y	.	.	.							

Finally on the display appears the message : EXECUTED OK. The procedure asks for another S/N to set and propose the number next to the last S/N used .

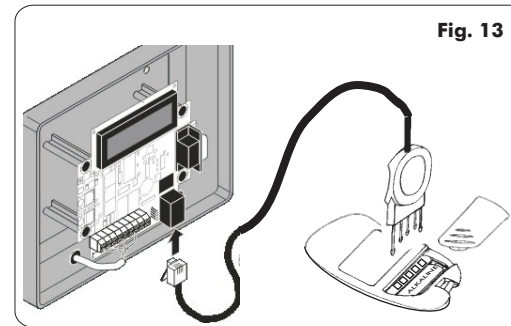

Fig. 13

Print user list

With the choice "COPY MEMORY ON A PRINTER", it is possible to print the list of the users stored to a Serial Printer (see connector 9 at pag. 2)

The transfer parameters are the following:

BAUD RATE: 2400 BAUD
 N BIT: 8
 PARITY: NONE
 STOP BIT: 1
 HANDSHAKE: NONE

The data memory are transferred through the RS232C to the device connected to the D-type 9-pin male connector. It is possible to connect also a PC or a Terminal with VT100 emulation (see connection diagrams at pag. 19). After the selection confirmation, on the LCD will appear 2 messages:

during the printing: COPY
 IN PROGRESS.....

at the end: COPY
 EXECUTED OK

Then the program return to the initial message. The printout allows to complete the list by hand with more information as the user name and the installation address.

Printout example

```

*** TRANSMITTER 800 ***

PASSWORD : 11111

FACILITY CODE : 000,00_

USER ADDRESS

to be filled by hand

USER N.   S/N    STATUS  RELAY   KEYS   USER NAME
0001     20609   E       1 / 2   A/B    to be filled by
0002     20608   E       1       B      hand
0801     11910   E       1 / 2   A/B

*** End of List ***
  
```

Print events

Each time a transmitter excites a relay, a string message is sent to the RS232 output.

The format of the string is the following:

[CR] UAAAA - FBB - SCCCC - RD - KE [LF]

Legend:

[CR] = Carriage Return;
 [LF] = Line Feed;
 U, F, S, R, K, = Code Letters;
 AAAA = User Number (0000 - 0807)
 BB = Facility Code (000 - 255);
 CCCCC = Serial Number (00000 - 65535);
 D = Relay activated (1 or 2 or 1/2);
 E = Transmitter key activated (A, B, C, D);
 ". " = Blank.

Example

Transmitter received with S/N = 05310, Facility code = 02,
 User number : 001;
 Transmitter key activated = A, Relay activated = 1

Signal output:

[CR] U0001 - F02 - S05310 - R1 - KA [LF]

Menu : Delete

This procedure begins at the point 2 of the main menu.

Through this procedure it is possible to delete:

- A single USER
- All the USERS
- The whole memory (Complete initialization of the receiver memory)

The structure of this sub-menu is the following:

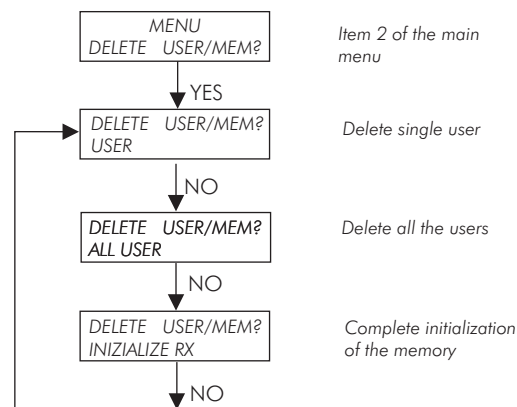

Use the LEFT key of the MASTER transmitter to scroll the different choices and select the operation to do with the RIGHT Key.

Use both keys of the MASTER transmitter to return back to the main menu.

Single user cancellation

With this choice you are asked for the Serial Number of the transmitter to delete:

```

DELEETE USER / MEM
USER SN 20609
  
```

Enter the S/N using one of the methods of pag.8 (TX Master, KEYPAD or key B of the transmitter to delete , where possible).

Finally will appear the message:

```

DELEETE SN 20609
ARE YOU SURE
  
```

In this case with an answer YES the transmitter with S/N 20609 will be deleted and both the parameters "free memory" and "stored TX number" will be updated.

All users cancellation

This option allows to delete all the USER transmitters and to keep in the memory the MASTER transmitters.

```

DELEETE USER / MEM
ALL USER ?
  
```

A further confirmation is required to finish the procedure

```

DEL ALL USER
ARE YOU SURE ?
  
```

With a final YES, the cancellation will be carried out the message "EXECUTED OK" appears on the display and the receiver returns to the initial message.

Complete initialization of the receiver

With this option the following actions are carried out:

- cancellation of all the USER transmitters;
- cancellation of all the MASTER transmitters;
- cancellation of the current password and restore of the default password ("11111").
- Restore at "0800 / 1619" of the free memory number
- Reset to "0000" of the stored transmitter number.

```

DELEETE USER / MEM
INIZIALIZE RX ?
  
```

With the answer YES you are asked for a further confirmation:

```

INIZIALIZE RX
ARE YOU SURE ?
  
```

With a final YES the memory is completely cancelled, the message EXECUTED OK appears and the receiver returns to the initial message.

Menu : Modify User

This procedure is at the item 3 of the main menu. Through this procedure it is possible to carry out the following actions on a USER transmitter, only if it is present in the memory:

- Modify the activated relay and the corresponding transmitter key;
- Enable or disable the single USER

M	O	D	I	F	Y	U	S	E	R						
U	S	E	R			S	N			2	0	6	0	9	

Set the Serial Number of the transmitter to modify by using the 3 methods allowed (TX MASTER, KEYPAD, Key B of the USER TX)

Then give the confirmation with the key YES of the TX MASTER

User Enable / Disable

The receiver checks the current situation and propose the corresponding changement

- If the USER transmitter id enabled, it asks to disable;
- if the USER transmitter is enabled, it asks to enable

U	S	E	R			S	N			2	0	6	0	9	
D	I	S	A	B	L	E	U	S	E	R					

With an answer YES the following message appears:

D	I	S	A	B	L	E	U	S	E	R					
A	R	E		Y	O	U		S	U	R	E				

With a final YES appears the message EXECUTED OK, the transmitter is disabled, the procedure ends and the program returns to the main menu.

If the transmitter is currently disabled, you are asked to enable.

U	S	E	R			S	N			2	0	6	0	9	
E	N	A	B	L	E		U	S	E	R					

With an answer YES the following message appears:

E	N	A	B	L	E		U	S	E	R					
A	R	E		Y	O	U		S	U	R	E				

With a final YES appears the message EXECUTED OK, the transmitter is enabled, the procedure ends and the program returns to the main menu.

Modify relay or key parameters

Once selected the Serial Number of the transmitter to modify, you are asked to set the relay and the key parameters:

U	S	E	R			S	N			2	0	6	0	9	
R	E	L	A	Y		O	R			K	E	Y			

With a YES, it is displayed the current configuration of the transmitter: activated relay and corresponding transmitter key.

The following table shows the association between relays and keys when the parameter RELAY is set to 1/2:

2-keys transmitter		
Key Option	A	B
Activations	A - Relay 1 B - Relay 2	B - Relay 1 A - Relay 2

4-keys transmitter				
Key Option	A	B	C	D
Activations	A -Relay 1 B -Relay 2	B -Relay 1 C -Relay 2	C -Relay 1 D -Relay 2	D -Relay 1 A -Relay 2

U	S	E	R			S	N			2	0	6	0	9	
R	E	L	A	Y	:	1/2				K	E	Y	:	A	

If the parameter RELAY is set to 1 or 2, only the key indicated causes the activation of the relay.

Once inside the options for the parameters RELAY and KEY, scroll the options available with the LEFT key of the TX MASTER and confirm with the RIGHT key.

OPTIONS RELAY : 1 - 2 - 1/2 - 1 - 2 - etc.
OPTIONI KEY : A - B - C - D - A - B - etc.

At the end the message EXECUTED OK appears and the program returns to the main menu.

NOTE : If you entry the S/N of a transmitter not in memory, the following message appears :

S	N		N	O	T		I	N		M	E	M	O	R	Y
U	S	E	R				S	N		2	0	6	0	9	

Copy and data transfer menu

Through this sub-menu it is possible:

- To visualize the memory on the display LCD;
- To print the list of the users;
- To programm the Serial number of a transmitter;
- To copy the internal memory data onto a backup memory;
- To restore the data from a backup memory.

Menu structure

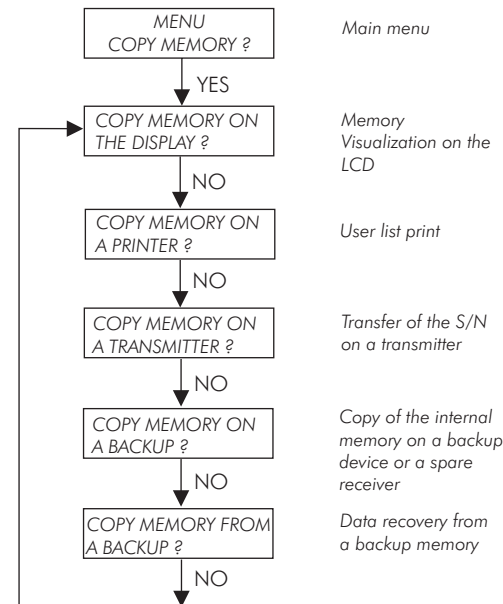

Memory Visualization on the LCD

The first option allows to visualize the data memory on the LCD display. The visualization is carried out line for line : each line contains all the information of the USER: Serial number, abilitation, activated relays, corresponding transmitter key. The first and the last transmitter are marked as: FIRST USER e LAST USER.

Use the keys of the MASTER transmitter to scroll up and down the list, as shown below:

- RIGHT key TX MASTER : scroll down the list;
- LEFT key TX MASTER : scroll up the list;
- LEFT+RIGHT keys simultaneously : back to upper menu;

Example : visualization of a receiver memory with 3 transmitters (2 User and 1 Master) :

